

Features: (typical values)

- Qorvo QPA2213 IN SMA-F
- Output Power..... +33dBm
- Gain +25dB
- Internal DC blocking capacitors.
- Unconditional Stability
- Requires +18V and -5V Supplies
- Requires heat sink
- All purposes HPA GaN driver
- Radar Systems
- Optional: Available in Single +28V Supply

**2 -20 GHz.
WIDEBAND GaN AMPLIFIER**

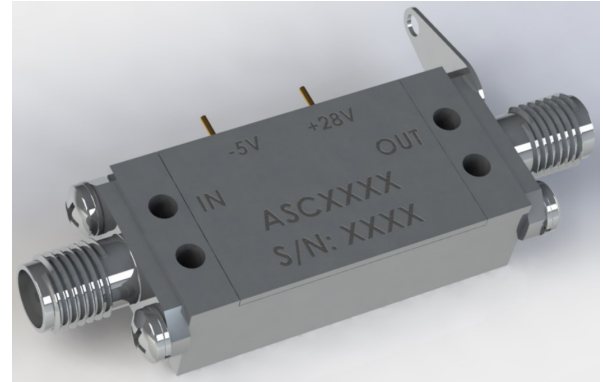

Maximum Ratings

Operating Base Temp.-30°C to +70°C
 Storage temperature-60°C to +125°C
 DC Operating Voltage +24V/-5V
 RF Input Power +27 dBm Max

Specifications @ Tcase = 25°C, Vcc = +18V and -5V, 50Ω systems unless otherwise noted.

Parameter	Typical Conditions	Min Value	Max Value	Units
Frequency Range		2	20	GHz.
Gain	25	20		dB.
Gain Flatness	±2.5			dB.
Input VSWR – 50 OHMS	2.5 : 1			-
Output VSWR – 50 OHMS	3.0 : 1			-
PAE @ Pin =18dbm	22			%
Output Power @+18dbm	33	32		dBm.
INPUT/OUTPUT Connector SMA-F				-
Supply Current Idq @ +18V Drain and -5V Gate	330			mA

TYPICAL GAIN, INPUT, AND OUTPUT RETURN LOSS PLOTS @ 25°C

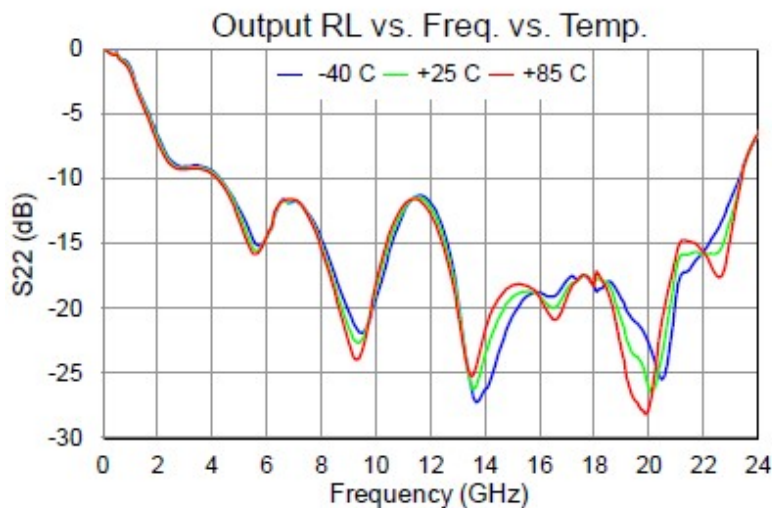
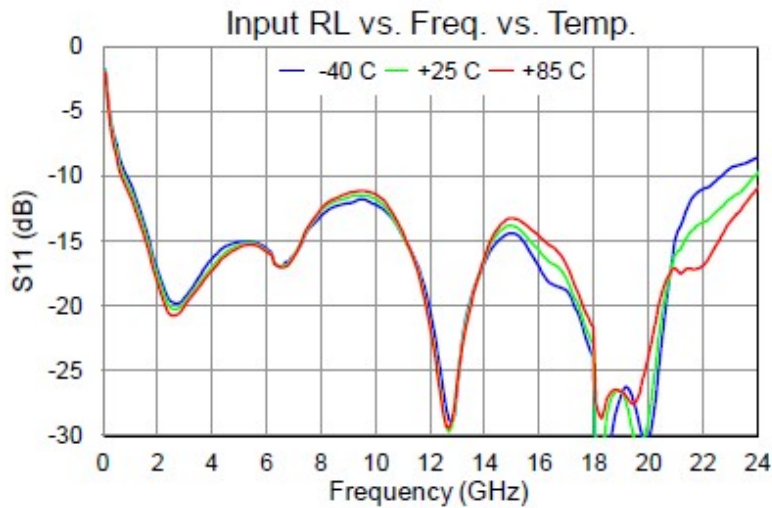
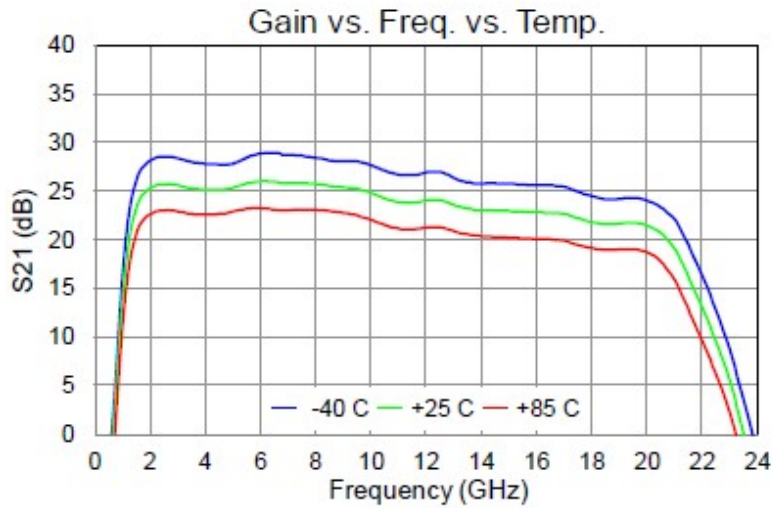

TYPICAL OUTPUT POWER PERFORMANCE @ 25°C

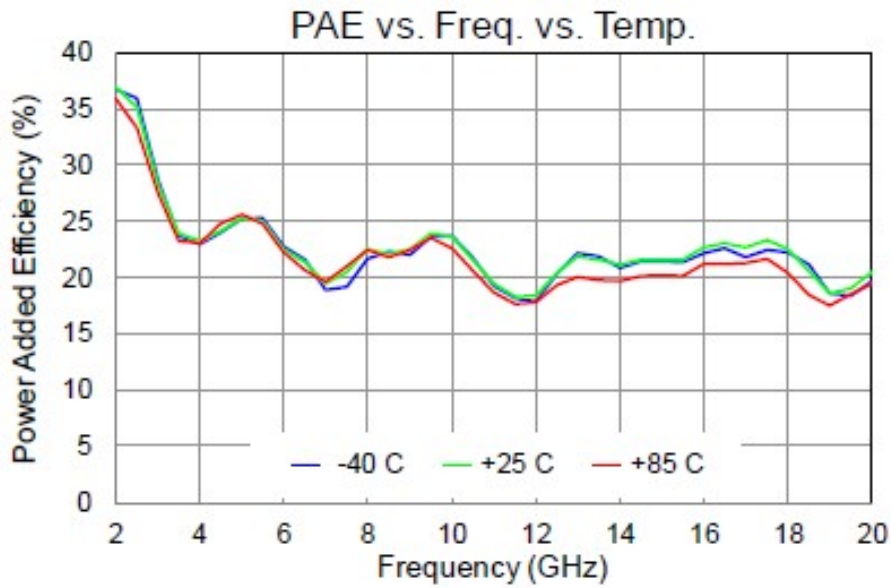
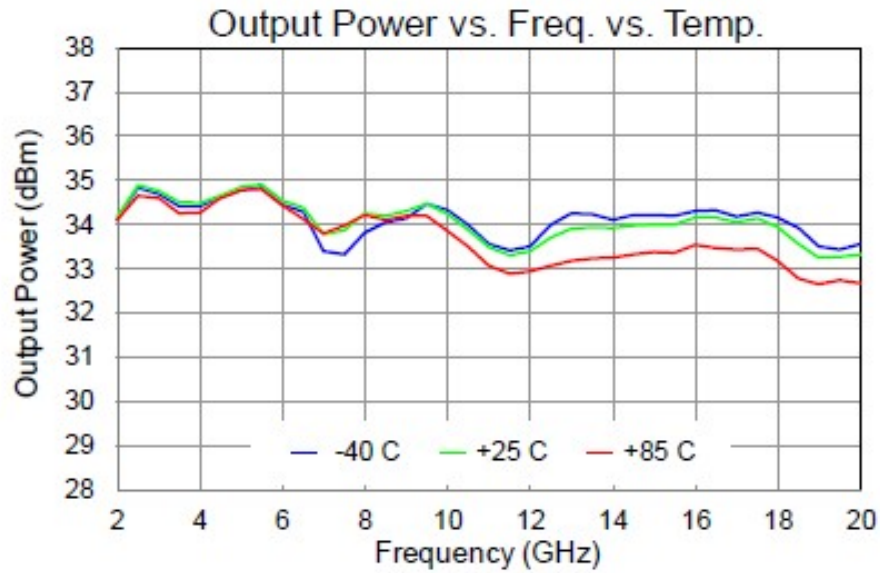

OUTLINE

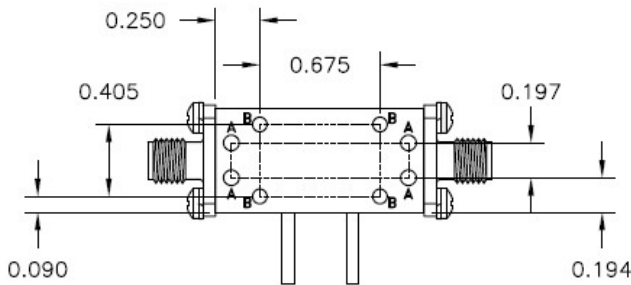
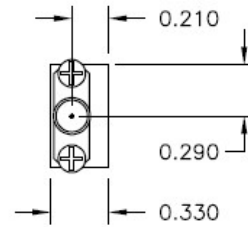
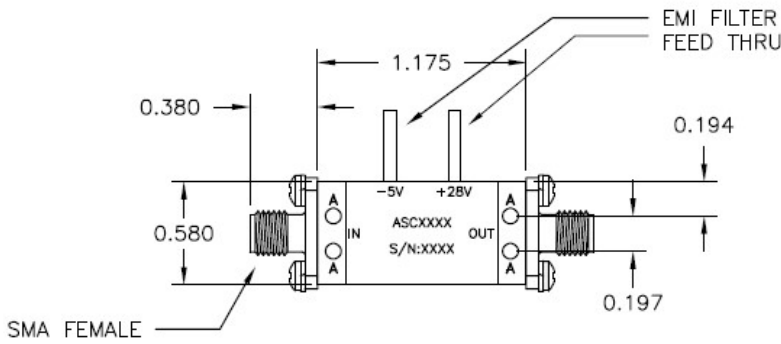
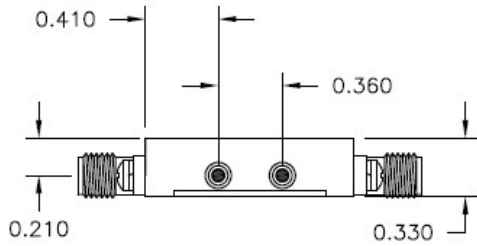

HOLE CHART	
HOLE	DESCRIPTION
A	∅0.090 THRU
B	#2-56-UNC-2B, .100 DP MIN

OPTIONAL FOR HOUSING SINGLE +28V SUPPLY

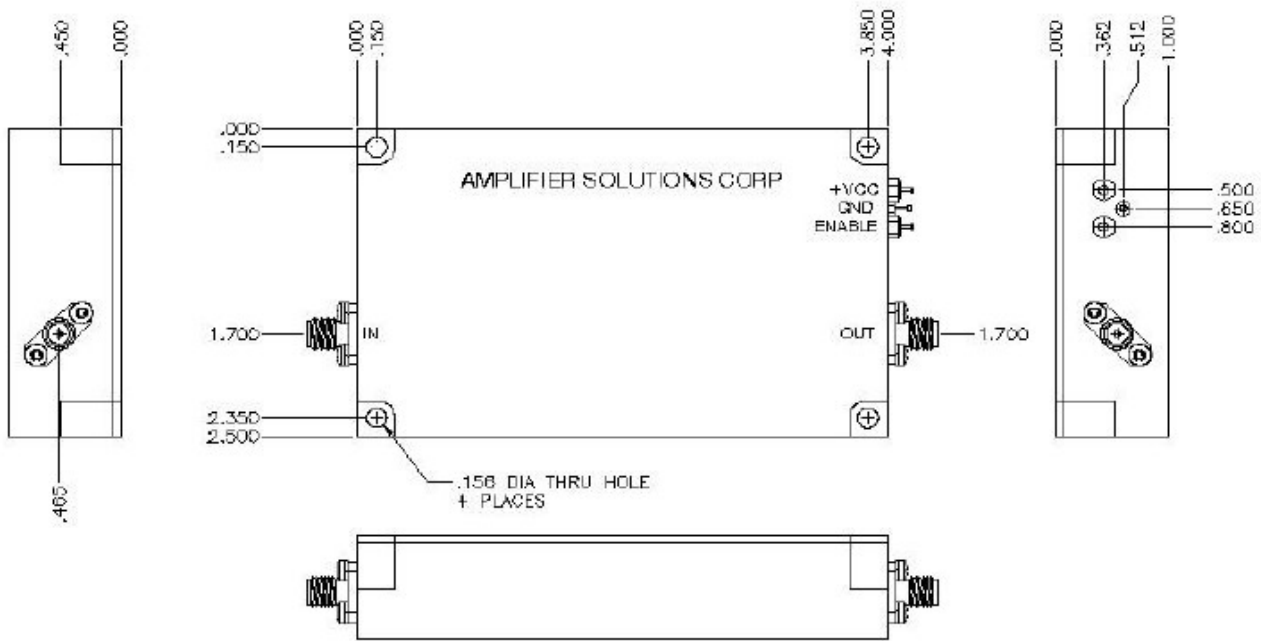

FUNCTIONAL BLOCK DIAGRAM

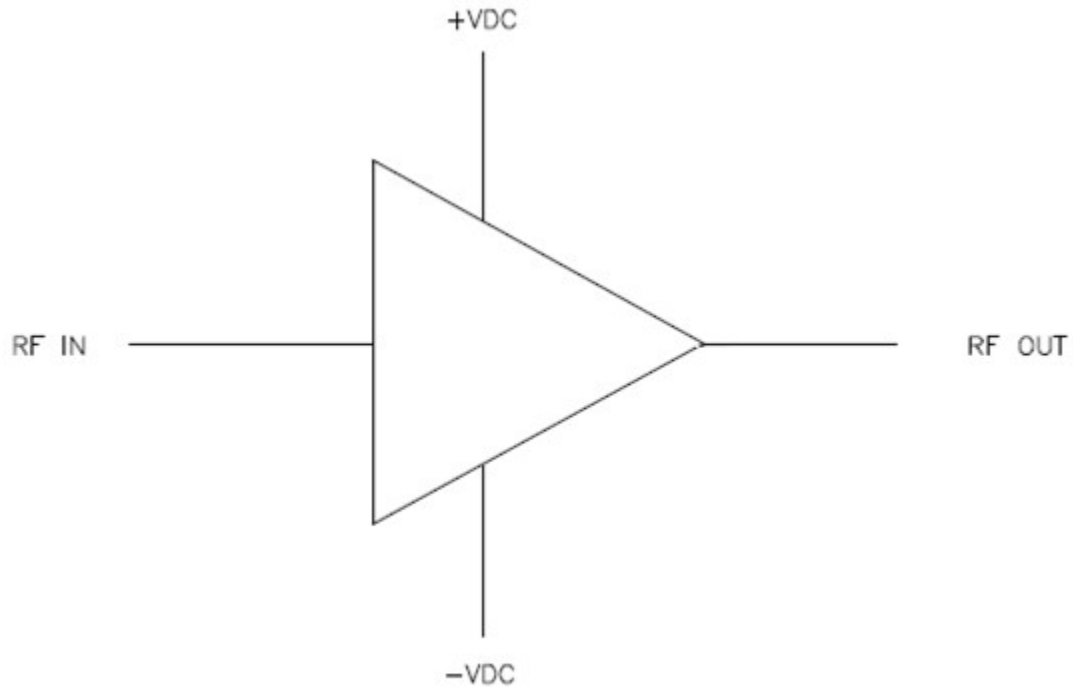

NO EXTERNAL COMPONENT REQUIRED